

SECTION A-A

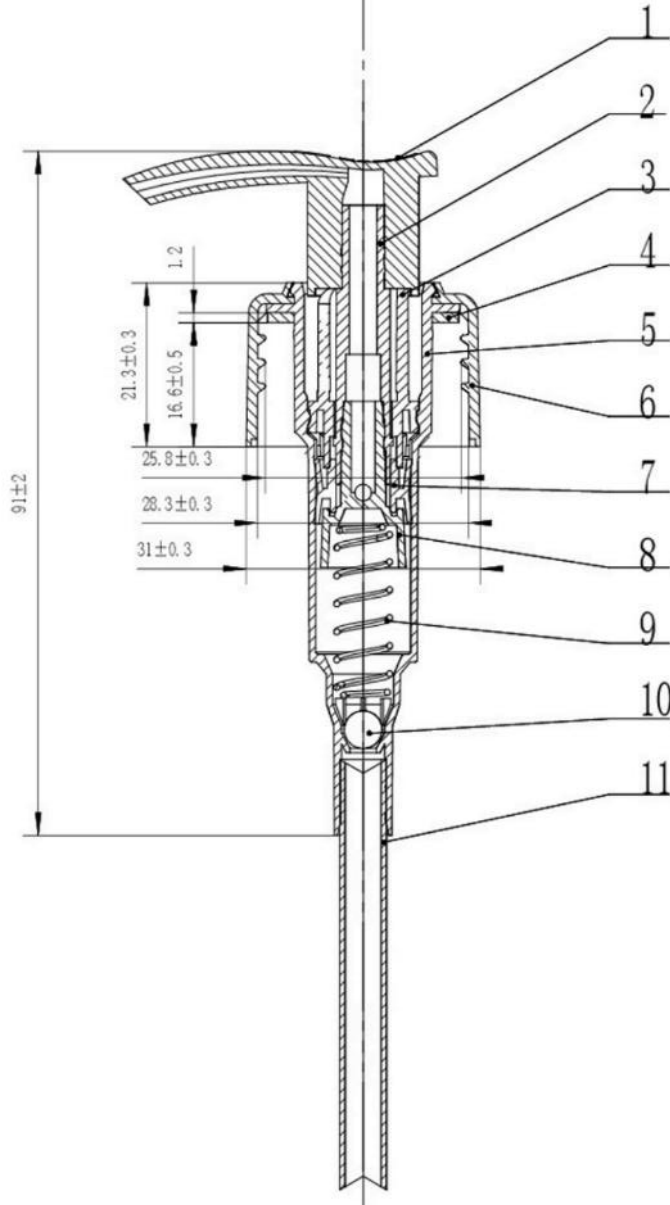

	COMPONENT NAME	MATERIAL
1	NOZZLE	PP
2	PISTON ROD	PP
3	SWITCH	PP
4	GASKET	PE
5	HOUSING	PP
6	CLOSURE	PP
7	PISTON	LDPE
8	PISTON SEAT	HDPE
9	SPRING	SUS
10	BALL	GLASS
11	DIP TUBE	LDPE

Rev.	Date	Modifications	Material	refer to drawing
00	21/08/23	First issue	Weight	n/a
			Scale	NTS
			Unit	mm
			Drawn by	Pump Supplier
			Approved:	<i>M. Bonnici</i>



Drawing no. LTA28410-MB-A028-23-00

Description: Pump Lotion 28410 Matt Black Smooth Collar

Controlled Document